

Data Sheet



Article number: 604145080040

Description: Timing belt pulley with hub
HTD 80 14M 40

Measures

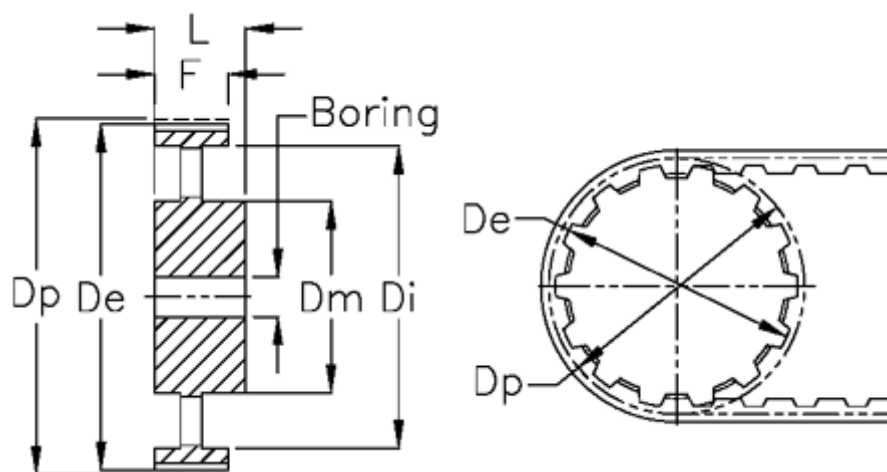

Bore	= 28	Type	= 14M
De	= 353.71	Weight	= 18.5
Di	= 314	Width	= 40
Dm	= 135		
Dp	= 356.51		
F	= 54		
L	= 69		
Tooth number	= 80		